

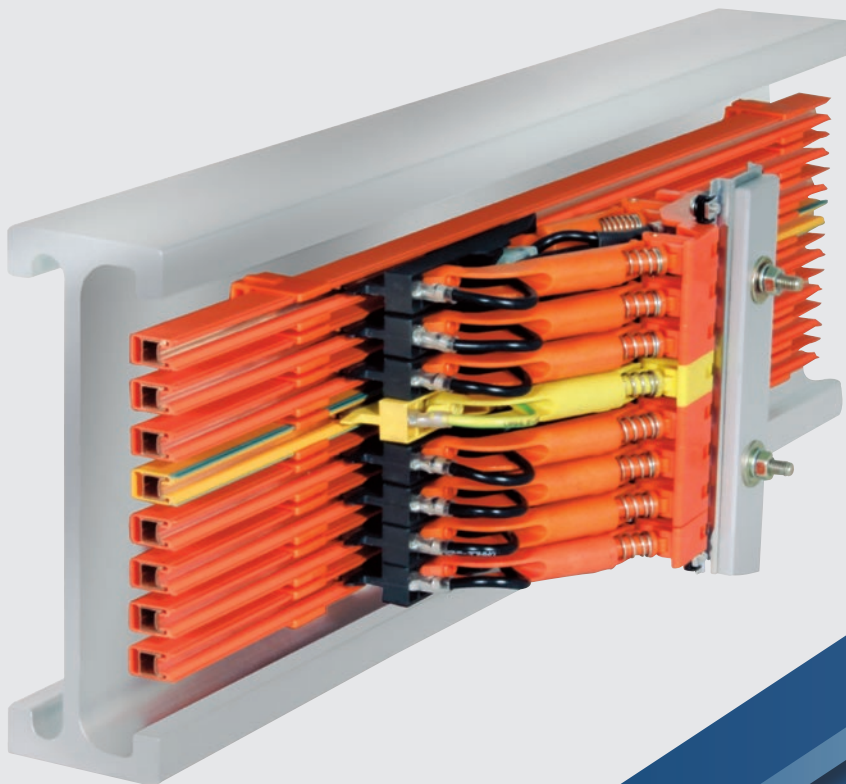

**INSULATED CONDUCTOR SYSTEM
FABA 100**



INSULATED CONDUCTOR SYSTEM FABA 100

CONTENTS

General	2	Fix point	7
Technical Data	4	Collectors	8
Joints	5	Wear parts for collectors	8
Feed Joints	5	Connecting cable	9
Isolating assembly	5	Terminal box	10
Expansion section	6	Brush wear indicator	10
End cap	6	Assembly accessories	11
Support for joint cap	6	Questionnaire	13
Spacer for support	6	Notes	14
Support point clamp	7		

GENERAL

FABA 100 insulated conductor system comply with VDE 0100. They satisfy today's requirements for conductor line safety and are protected against accidental contact in compliance with VDE 0470, Part 1 (Safety Class IP 21).

Naturally for the collector this contact protection exists only when the brushes are completely in the conductor rails. Conductor lines systems in the manual area, in which the collector moves out of the conductor rail during operation, require provisions by the customer to prevent accidental contact such as blocking off or switch-off. However this applies only for voltages above 25 VAC or 60 VDC. Fig. 1 (top right) shows that the VDE finger cannot make contact with the conductive parts.



Fig 1: VDE-Finger

The insulating shrouding for mounting the conductor rail channel provides good insulation and maximum safety.

Conductor lines with any number of poles can be used. The space requirement is minimal.

The standard delivery length is 5 m, shorter lengths are also available.

The ground conductor is marked with yellow with a continuous green stripe along the insulating shrouding.

Provisions are present to prevent mixing up the collectors for ground and phases.

USE

Indoor applications only. Outdoor applications only after consultation.

APPROVALS

UL approved. Please consult us when ordering.

SUPPORT DISTANCE

The maximum suspension interval between compact hangers is 0.8 m, in curves 0.4 m.

JOINTS

The conductor sections are connected electrically and mechanically with rail connectors. Each joint is protected against accidental contact by a cover.

EXPANSION

Use only centered, fixed points for straight systems up to 60 m. If the length of the conductor system is subject to change (caused by variations in the ambient temperature and/or power heat-up) mount the conductor rails in fix point clamps so that they can slide.

On systems over 60 m and in straight sections between curves provide for expansion points. If both ends of the rail are fixed (switches, elevators), expansion sections are also required.

FEED TERMINALS

Feed terminals are possible as joint feed. Our product line also includes joint caps and isolating assemblies with feed connection possibilities.

JOINT CAPS

Joint caps protect the conductor rail against accidental contact and separate the rails mechanically (switches, elevating stations, etc.). Joint caps are available with and without feed terminals.

ISOLATING ASSEMBLIES

Isolating assemblies interrupt the conductor system electrically. Operationally driving over collectors for the purpose of connecting or disconnecting the power is permissible only at low power (control currents). We supply isolating assemblies with and without feed terminals for control purposes, in-feed sections, maintenance sections, etc.

CURVES

Insulated conductor system FABA 100 can be used in horizontal and vertical curves. The rails can be bent on site with a special bending tool.

COLLECTORS

The collectors consist of impact-resistant plastic and reinforced metal parts. The power is drawn with a carbon brush.

The length of the collector connecting cable must not exceed 3 m, when the overload protector is not laid out for the load rating of this connecting cable. See also DIN VDE 0100, Part 430 and DIN EN 60204-32. (Note: The former occurs frequently when a number of collectors are present per system.)

The connecting cables supplied are sufficiently dimensioned for the rated currents specified. It is necessary to take the reduction factors specified in DIN VDE 0298-4 into consideration for other types of laying.

SAFETY NOTE

To avoid pinching hazards it is necessary to ensure that the safety intervals between fixed and moving system parts (0.5 m) are maintained by arranging the conductor rails/conductor lines and collectors/towing arms accordingly at site!

PROPERTIES (ELECTRICAL)

Chemical resistance:⁽¹⁾ Highly resistant to gasoline, oils, weak alkalies and weak acids

Type	Dielectric insulation DIN 53481	Specific resistance IEC 60093	Surface resistivity IEC 60093	Leakage path resistance IEC 60112	Ambient temperature range ⁽²⁾	Combustibility
Standard version, orange	>22.4 kV/mm	>8 x 10 ¹⁵ Ohm x cm	2 x 10 ¹³ Ohm x cm	CTI 600 – 1.1	–30 °C to +55 °C	Flame resistant, self extinguishing, UL 94

PROPERTIES (MECHANICAL)

Chemical resistance:⁽¹⁾ Highly resistant to gasoline, oils, weak alkalies and weak acids

Type	Dielectric insulation DIN 53481	Specific resistance IEC 60093	Surface resistivity IEC 60093	Leakage path resistance IEC 60112	Ambient temperature range ⁽²⁾	Combustibility
Heat-resistant version, halogen-free, orange	> 22.4 kV/mm	> 8 x 10 ¹⁵ Ohm x cm	2 x 10 ¹³ Ohm x cm	CTI 600 – 1.1	–30 °C to +80 °C	Flame resistant, self extinguishing, UL 94

(1) Please check with us before using in systems with synthetic oils and greases.

(2) Please check separately for applications with continuous temperatures below 0 °C (cold storage)

TECHNICAL DATA

SECTION

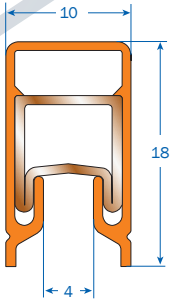

PART NUMBER CODE

FABA = Insulated Conductor Rails
 100 = Current rating in A
 25 = Conductor cross section (mm²)
 C = Copper conductor

LENGTH

5 m standard length,
 shorter lengths possible

SUPPORT SPACING

for straight sections 0.8 m
 in curves 0.4 m

CONDUCTOR SPACING

Standard = 15 mm

CONDUCTOR RAILS CAN BE BENT

at the factory or on the construction site
 with special FABA 100 curve too

CHEMICAL AND ELECTRICAL VALUES

see page 4

USE

for indoor systems only,
 please contact us for consultation for outdoor systems

STANDARD VERSION

Type	Weight kg/pc	Length m	Order No. Phase	Order No. PE
F100C-100-5000PH-Y	1.339	5	2805928	-
F100C-100-5000PE-Z	1.339	5	-	2805931
F100C-100-3000PH-Y	0.810	3	2805927	-
F100C-100-3000PE-Z	0.810	3	-	2805930

HEAT-RESISTANT VERSION

Type	Weight kg/pc	Length m	Order No. Phase	Order No. PE
F100C-100-5000PH-Y80	1.339	5	2823826	-
F100C-100-5000PE-Z80	1.339	5	-	2823827
F100C-100-3000PH-Y80	0.810	3	2823830	-
F100C-100-3000PE-Z80	0.810	3	-	2823831

CONDUCTOR SYSTEM VALUES

Type	Conductor cross section Cu mm ²	Jacket creep path mm	max. Voltage	max. continuous current A	Resistance Ohm/1000 m	Impedance ⁽¹⁾ Ohm/1000 m
Conductor rails FABA 100	25	32	1000	100	0.77	0.78

(1) At phase interval of 15 mm and frequency of 50 Hz.

JOINTS

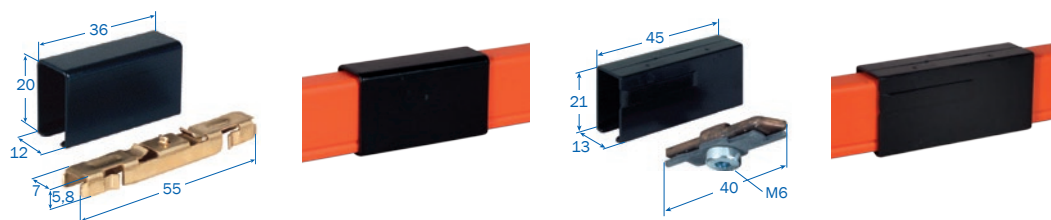

Type	Description	Weight kg	Order No.
VM-FVST100	Joint	0.008	2806668
VM-FVS100	Bolted Joint	0.017	2806664

FEED JOINTS

Use: 100 A for fix point clamps, construction height 32 mm

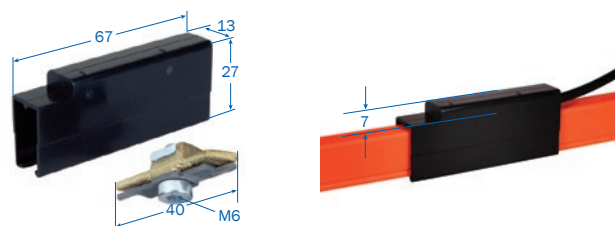

Type	Description	Weight kg/m	Order No.
ES-FSE100-50A-27	Feed Joint 50 A	0.024	2807174
ES-FSE100-100A-32	Feed Joint 100 A	0.030	2807148

ISOLATING ASSEMBLY

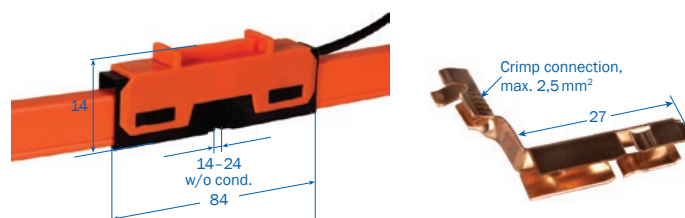

Type	Description	Symbol	Weight kg	Order No. Construction height 27	Order No. Construction height 32
EU-ET/ET100-27	Separation without connecting cable		0.025	2807352	-
EU-ET/ET100-32			0.027	-	2807353
EU-ET/ETE100-27-2,5-1	Separation with 1 connecting cable		0.067	2807367	-
EU-ET/ETE100-32-2,5-1			0.069	-	2807368
EU-ETE/ETE100-27-2,5-1	Separation with 2 connecting cables		0.083	2807364	-
EU-ETE/ETE100-32-2,5-1			0.085	-	2807365
EU-ETB/ETB100-27-2,5-0,45	Separation with jumper cable		0.034	2807370	-
EU-ETB/ETB100-32-2,5-0,45			0.036	-	2807371

EXPANSION SECTION

Note: Expansion without jumper line suitable for max. 50 A

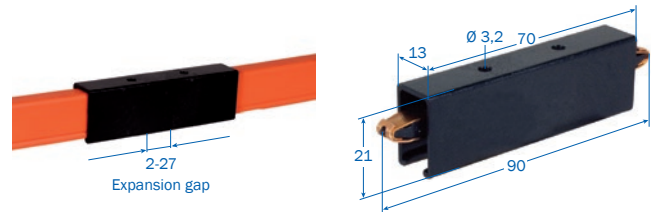

Type	Description	Weight kg	Order No. Phase	Order No. PE
DV-FDV100-50A-25	Expansion section	0.022	2809008	2809008
AL-RKLA6PH1,6-M6-RK-M6	Jumper cable	0.142	2810537	-
AL-RKLA6PE1,6-M6-RK-M6	Jumper cable	0.178	-	2810538

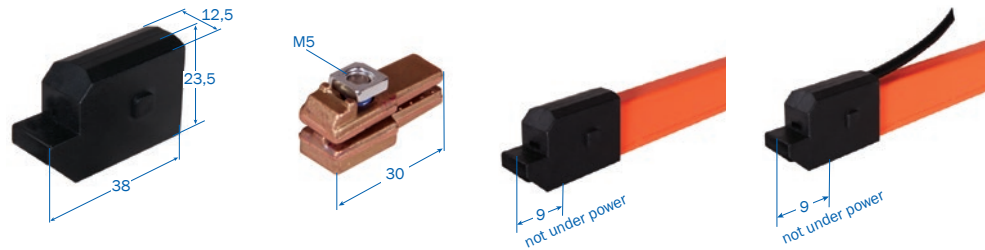

END CAP

with or without feed terminal (used as end cap and in combination with support as fix point)

Max. perpendicular and lateral off set: 2 mm in relation to one another. Please contact us for higher tolerances.

Type	Description	Weight kg	Feed	Order No. PE
MU-FUK100-K-PC	Transition cap w/o feed connection possibility	0.005	w/o	2807210
MU-FUKE100-K	Transition cap with feed connection possibility	0.026	for max. 2.5 mm ²	2807213

SUPPORT FOR JOINT CAP

for screwing to the track, arrangement as desired depending on number of poles

Support can be adjusted by ± 5 mm in direction of conductor.

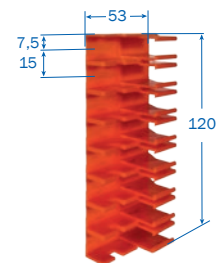

Type ^{(1),(3)}	Weight kg	No. of poles	Width mm	Order No.
MU-FTUK100-8/27-7-120-PC	0.038	8	120	2806793

SPACER FOR SUPPORT

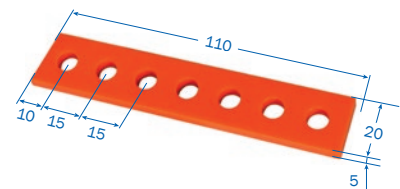

Type ^{(2),(3)}	Weight kg	No. of poles	Width mm	Order No.
MU-FDST100-8-5-110	0.010	8	110	2807294

(1) For construction height 27 mm

(2) For construction height 32 mm

(3) Order mounting hardware separately

SUPPORT POINT CLAMP

With support clamps
any number of poles can be connected together.

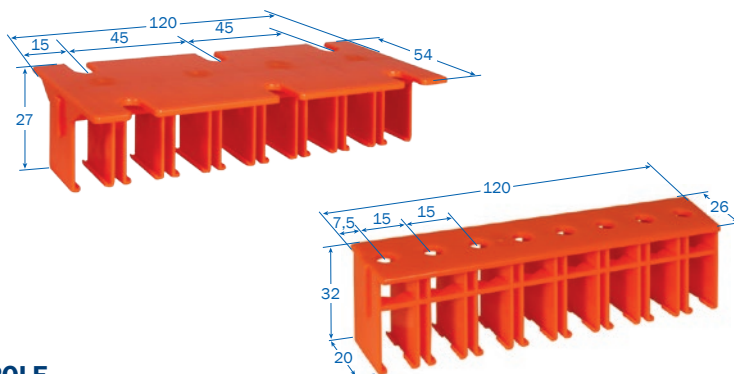

SUPPORT CLAMP FOR SCREWING ON, UP TO 8-POLE

Rail interval 15 mm

Type	Weight kg	Number of poles or assignment	Length L	Construction height	Order No.
AH-FSKA100L-8/27-PC	0.030	8	120	27	2806822
AH-FSKA100L-8/32-12-PC	0.025	8	120	32	2807012

SUPPORT CLAMP, SPECIAL VERSION, UP TO 10-POLE

Production for your system on request.

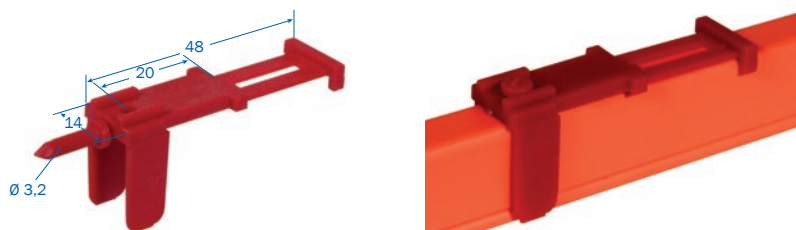
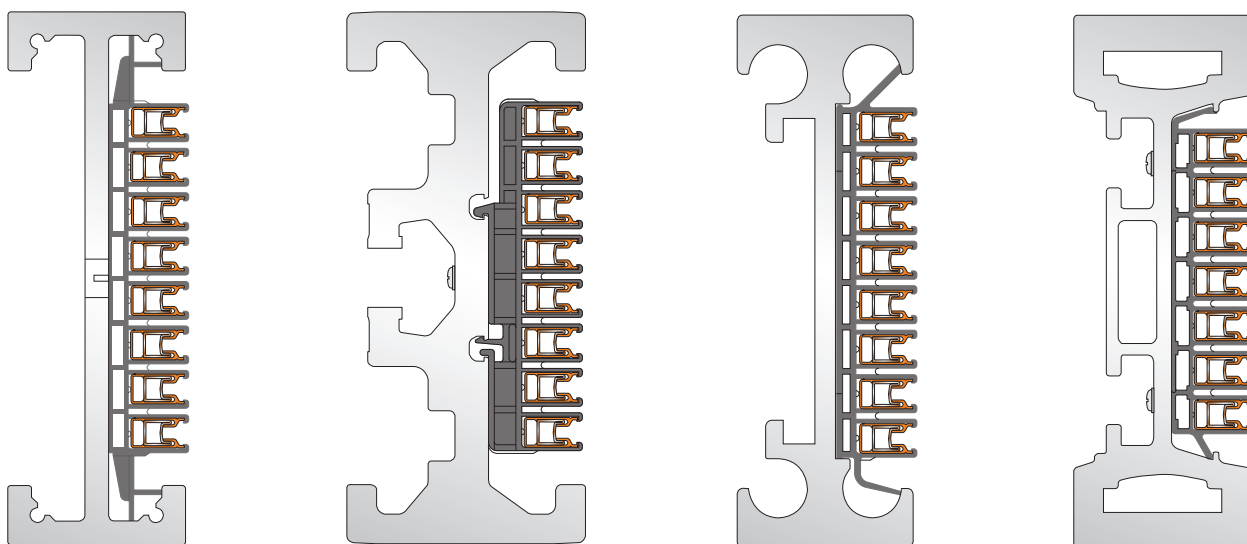

FIX POINT

Type	Weight kg	Order No.
SF-FPL100	0.002	2807042

COLLECTORS

COLLECTOR SET D-EAS

suitable for funnel

Phase distance: 15 mm

Max. current: 30 A

Lift: ± 12 mm

Lateral tolerance: ± 20 mm

Pressure: ca. 4 N per brush

PE at position 4 with 3 poles at, other arrangements possible!

Ground is always first contact.

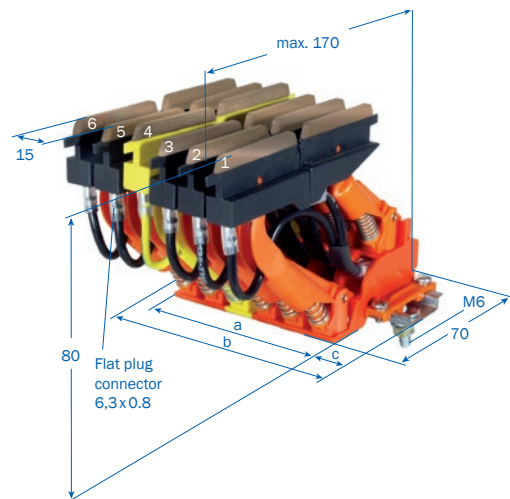

Type	No. of poles	Dim. a mm	Dim. b mm	Dim. c mm	Weight kg	Support rail	Order No.
SA-DEAS-2/30-1-HS-2,5-1/1-1	1	15	50	17,5	0.172	1-pole	2823603
SA-DEAS-2/30-2-HS-2,5-1/2-2	2	30	75	22,5	0.302	2-pole	2823604
SA-DEAS-2/30-3-HS-2,5-1/3-4	3	45	100	27,5	0.432	4-pole	2823605
SA-DEAS-2/30-4-HS-2,5-1/4-4	4	60	100	20,0	0.550	4-pole	2823606
SA-DEAS-2/30-5-HS-2,5-1/4-6	5	75	125	25,0	0.680	6-pole	2823607
SA-DEAS-2/30-6-HS-2,5-1/4-6	6	90	125	17,5	0.798	6-pole	2823608
SA-DEAS-2/30-7-HS-2,5-1/4-8	7	105	150	22,5	0.928	8-pole	2820991
SA-DEAS-2/30-8-HS-2,5-1/4-8	8	120	150	15,0	1.046	8-pole	2820993
Available separately							
SA-DEAS-2/30-PH-6,3-PC-36	1	15	-		0.091	w/o	PH 2808560
SA-DEAS-2/30-PE-6,3-PC-36	1	15	-		0.089	w/o	PE 2808561

WEAR PARTS FOR COLLECTOR

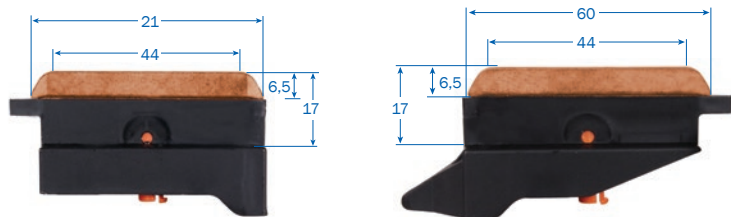

REPLACEMENT HEADS FOR COLLECTOR DEAS

Type	Description	RH/mm	Weight kg	Order No. Phase	Order No. PE
SK-EK-DEAS-2/30-PH-36-6,3-H	Rear replacement head	0.5	0.016	2808580	-
SK-EK-DEAS-2/30-PE-36-6,3-H				-	2808581
SK-EK-DEAS-2/30-PH-36-6,3-V	Front replacement head	0.5	0.016	2808575	-
SK-EK-DEAS-2/30-PE-36-6,3-V				-	2808576

CONNECTING CABLE

CONNECTING CABLE, DOUBLE INSULATION, HIGHLY FLEXIBLE

for collectors, length: 1 m

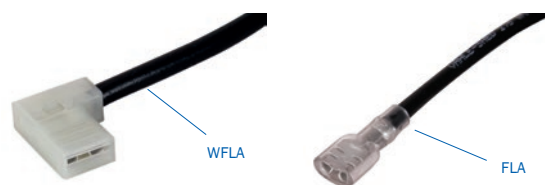

Type	Cross section mm ²	A Ø mm	Weight kg	Order No. Phase black	Order No. PE green/yellow
AL-WFLA2,5PH1-6,3	2.5	4.5	0.038	0168107-1	-
AL-WFLA2,5PE1-6,3			0.034	-	0168108-1
AL-FLA2,5PH1-6,3	2.5	4.5	0.078	2809171	-
AL-FLA2,5PE1-6,3			0.034	-	2809175
AL-FLA4PH2-6,3	4.0	5.3	0.064	2823085	-
AL-FLA4PE1-6,3			0.058	-	2823086

CONNECTING CABLE, DOUBLE INSULATION, FLEXIBLE

for feed joint with cable lug M6, length: 1 m



Type	Cross section mm ²	A Ø mm	Weight kg	Order No. Phase black	Order No. PE green/yellow
AL-RKLA2,5PH1-M6	2.5	4.5	0.038	2808979	-
AL-RKLA2,5PE1-M6			0.036	-	2808978
AL-RKLA4PH1-M6-HL	4.0	5.3	0.058	2808751	-
AL-RKLA4PE1-M6			0.052	-	2808752
AL-RKLA6PH1-M6	6.0	6.5	0.084	2808745	-
AL-RKLA6PE1-M6-HL			0.086	-	2808759
AL-RKLA10PH1-M6-HL	10.0	8.3	0.147	2808753	-
AL-RKLA10PE1-M6-HL			0.135	-	2808754
AL-RKLA16PH1-M6-HL	16.0	10.7	0.236	2808756	-
AL-RKLA16PE1-M6-HL			0.206	-	2808762

CONNECTING CABLE, DOUBLE INSULATION, FLEXIBLE

for joint cap with cable lug M5, length: 1 m



Type	Cross section mm ²	A Ø mm	Weight kg	Order No. Phase black	Order No. PE green/yellow
AL-RKLA2,5PH1-M5	2.5	4.5	0.038	2808971	-
AL-RKLA2,5PE1-M5			0.036	-	2808958

TERMINAL BOXES

TERMINAL BOXES AKE

for feed terminal and isolating assembly,
max. 7 terminals 6 mm²

2 terminals 6 mm² PE

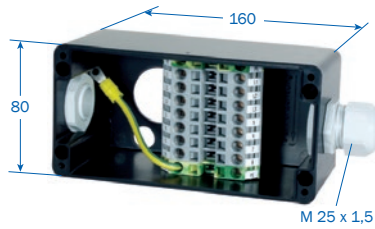

Type	Weight kg	Order No.
ES-AKE1-PH7 x 2L6-PE2 x 2L6-M25	0.445	169462

TERMINAL BOXES AKB

for separating sections



Type	Weight kg	Order No.
ES-AKB1-PH4x2L6-PE2x2L6	0.469	169481

BRUSH WEAR INDICATOR

BRUSH WEAR INDICATOR KVT 100 N

The brush wear indicator automatically checks the brushes for wear. A pulse is triggered when a brush is worn out. Installation in front of a repair section is practical for automatic operation of a switch. Adjusted at factory. Required cutout in FS channel. Length: 80 mm, height: see table.

Suitable for travel speeds up to 75 m/min.

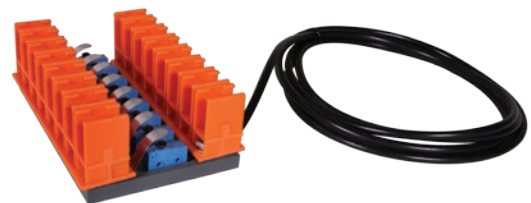

Type	Weight kg	No. of poles	Height	Order No.
VT-KVT100-2-NC	0.376	2	32	2807533
VT-KVT100-3-NC	0.340	3	47	2807534
VT-KVT100-4-NC	0.368	4	62	2807535
VT-KVT100-5-NC	0.268	5	77	2807536
VT-KVT100-6-NC	0.356	6	92	2807537
VT-KVT100-7-NC	0.356	7	107	2807538
VT-KVT100-8-NC	0.404	8	122	2807539

ASSEMBLY ACCESSORIES

CURVE TOOL

for bending FABA 100 vertically and horizontally.

Order filling rods separately.

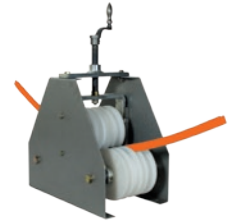

Type	Description	Weight kg/m	Order No.
MZ-BVF100	Curve tool FABA 100	18.031	2809323
MZ-BSF100-6,8X3,2-100-HB-PVCR-S	Filling rods 100 m in rolls	0.032	2806611
MZ-BPF100-5-VB-PVCS-R	Curve Profile 5 m in rods	0.250	2806612

TABLE SAW

for cutting insulator and conductor profiles with length gauge. Connection:

230Volts, 50Hz..



Type	Description	Weight kg/m	Order No.
MZ-KS10	Table saw	6.500	165276
MZ-SB	Replacement saws spare blade SB	0.070	165263

CONDUCTOR JOINT ASSEMBLY TOOL

For connecting with joints.



Type	Weight kg	Order No.
MZ-VZF100	1.420	2809345

ALLEN SCREW SW 4



Type	Weight kg	Order No.
Allen screw SW 4 mm	0.036	2812962

ASSEMBLY ACCESSORIES

ASSEMBLY HANDLE FOR JOINTS, PLUGABLE



Type	Weight kg	Order No.
MZ-MGF100	0.010	2812962

DEBURRING TOOL FLAT HAND FILE FSF

for deburring the outer face of the profile for short sections



Type	Weight kg	Order No.
Flat Hand File FSF 150x16x4	0.085	2812964

SCREW DRIVER PH1



Type	Weight kg	Order No.
Screw driver PH 1	0.014	2812963

QUESTIONNAIRE

Company: _____ Date: _____

Fon: _____ Fax: _____

E-mail: _____ Internet: _____

1. Number of conductor system installations: _____
2. Type of equipment to be powered: _____
3. Operating voltage: _____ Volt Frequency: _____ Hz
 Three-phase voltage AC voltage DC voltage
4. Track length: _____
5. Number of conductors: _____ neutral: _____ control: _____ ground: _____
6. Mounted position of conductor system:
 Conductor system pendant, collector cable facing to the bottom Conductor system pendant, lateral payout of conductor cable⁽¹⁾
 Support distance _____ m (max. 2 m) Other: _____
7. Number of consumers per system: _____
8. Indoor system Outdoor system
9. Other operating conditions (humidity, dust, chemical influence, etc.) _____
10. Ambient temperature: _____ °C min. _____ °C max.
11. Hall expansion joints _____ pieces _____ expansion max.
12. Position and number of feeding points⁽¹⁾: _____
13. Position and number of isolating sections (e.g. for maintenance)⁽¹⁾: _____
14. How will the conductor be arranged?⁽¹⁾: _____
15. Brackets required: Yes No c/c distance beam/conductor system: _____
16. Travel speed: _____ m/min. in curves: _____ m/min. at transfers: _____ m/min.
17. Max. voltage drop from the conductor system feed point to the consumer considering starting current. _____
18. Power consumption of the individual consumer loads: _____

Motor data	Crane 1						Crane 2							
	Power kW	Nominal current			Starting current		Type of motors ⁽²⁾	Power kW	Nominal current			Starting current		Type of motors ⁽²⁾
		A	cos φ _N	% duty	A	cos φ _A			A	cos φ _N	% duty	A	cos φ _A	
Hoist motors														
Auxiliary hoist														
Long travel														
Cross travel														

Mark with * those motors which can run simultaneously.

Mark with Δ those motors which can start up simultaneously.

Further remarks: _____

Signature: _____

(1) For curved tracks, powerail with isolating sections etc., we require sketches to enable us to prepare a quotation

(2) Use: K for squirrel cage motor, S for slipring motor, F for frequency controlled motor

We reserve all rights to make alterations in the interests of further development
Please copy and fill in the questionnaire.

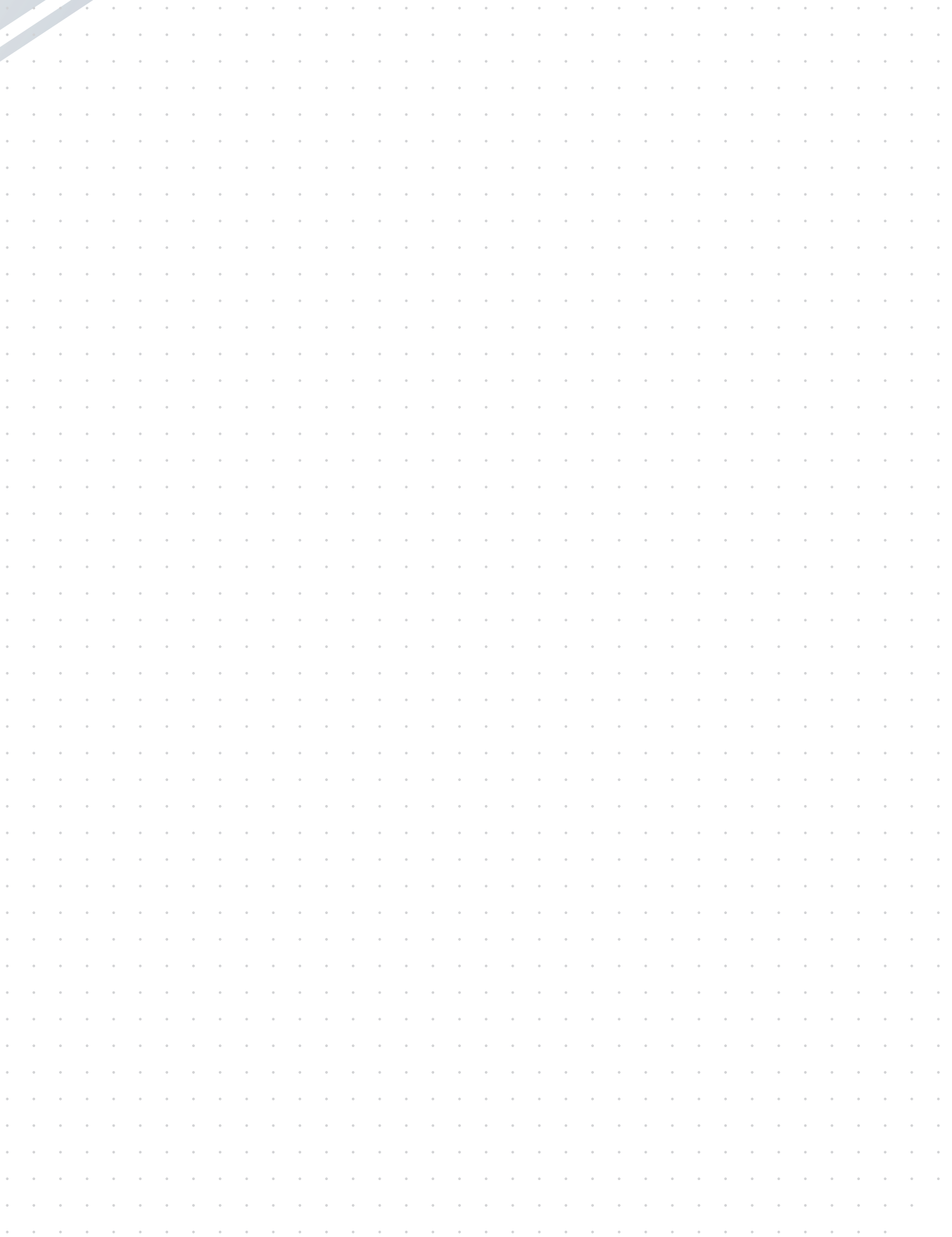
NOTES

NOTES



A large grid of small dots for taking notes, covering most of the page. The dots are arranged in a regular pattern, forming a grid that is approximately 30 columns wide and 40 rows high. The grid is intended for writing notes.



Paul Vahle GmbH & Co. KG

Westicker Str. 52
59174 Kamen
Germany

Tel.: +49 2307 704-0
Fax: +49 2307 704-444
info@vahle.de

www.vahle.com